

Remote Actuator Unit (RAU) for DD-Frame (D7)

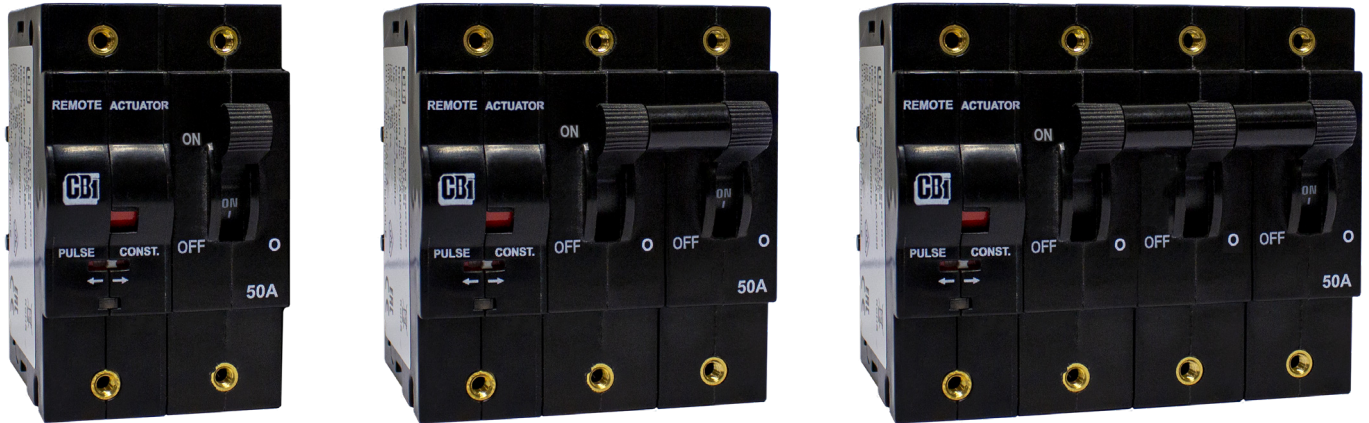

Features

- Remote actuator unit is factory-fitted on the left hand side of the DD-Frame circuit breaker
- The RAU module is designed to function on a wide voltage range: 18 Vdc to 80 Vdc
- **The RAU can be supplied from main system voltage or a standalone source**
- The DD-Frame circuit breaker operates on the main system voltage, AC or DC
- LED for status indication
- Selectable pulse or constant actuate signal operation
- Provides status of the load side of the circuit breaker
- Can be paired with up to a 3 pole DD-Frame circuit breaker
- Actuation of circuit breaker occurs internally
- Compact size (19 mm, matching DD-frame outline)

Applications

- Battery management
- Telecommunications
- Railways
- Solar
- System automation
- Switching operations in distant, inconvenient or unreachable environments

The remote actuation unit (RAU) is a factory-fitted module that enables the automated switching of a DD-Frame circuit breaker. The RAU internally actuates the circuit breaker both ON and OFF. The RAU is mounted on the left hand side of the circuit breaker and can actuate up to three poles. The RAU is available with circuit breakers with a standard toggle handle only. The unit has an LED that provides an indication of the mode of operation (PULSE or CONSTANT). A colour flag shows the position of the latch mechanism of the connected circuit breaker - green for OFF and red for ON. The RAU provides the option to set the actuation signal voltage between pulse or constant mode. This is selected by a switch situated on the front of the RAU.

Approvals



(UL489A) (CSA C22.2 No. 5-16)



(UL489; CSA C22.2 NO.5)



(UL1077; CSA C22.2 NO.235-04)



(IEC / EN 60947-2; IEC / EN 60934)



(GB14048.2; GB17701)



(IEC 60947-2; IEC 60934)



(IEC 60947-2)

Remote Actuator Unit (RAU) for DD-Frame (D7)

Technical Data

| Product Type | RAU | | DD Frame |
|---|---|------------------------------|---|
| Supply voltage | 18 Vdc to 80 Vdc | | All values as per DD Frame Circuit Breaker Data Sheet |
| Actuation signal voltage (For other voltages refer to page 11) | HIGH (ON) | Min. 3.3 Vdc to Max. 60 Vdc | |
| | LOW (OFF) | Min. 0.0 Vdc to Max. 0.5 Vdc | |
| Starting current | < 250 mA | | |
| Number of poles that can be actuated | 1 to 3 pole DD-Frame - factory fitted | | |
| Ambient operating temperature | -40 °C - +65 °C | | |
| Typical actuation time | OFF state to ON state | 2 seconds | |
| | ON state to OFF state | 1 second | |
| Power consumption | Idle mode | < 250 mW | |
| | During actuation | < 7.5 W | |
| Number of operations | In excess of 2000 | | |
| Flammability | I3 No flames persistence at 850 °C | | |
| Toxicity | F2 - Smoke index of ≤ 40 | | |
| Pollution degree | PD2 - Normally only non-conductive pollution occurs. Temporary conductivity caused by condensation is to be expected. | | |
| Signal Out Resistance to LOAD terminal | 330 kΩ ±5% (2 W) | | |

| Product Type | Circuit Breaker | Circuit Breaker | Circuit Breaker | Circuit Breaker |
|------------------|---------------------------------------|---------------------------------------|---------------------------|----------------------|
| Approvals | IEC / EN 60947-2, GB14048.2, CE, UKCA | IEC / EN 60947-2, GB14048.2, CE, UKCA | IEC60947-2, CE, UKCA | AS/NZS 60947-2, UKCA |
| Number of Poles | RAU + 1, RAU + 2, RAU + 3 | RAU + 2, RAU + 3 | RAU + 1, RAU + 2, RAU + 3 | RAU + 1, RAU + 2 |
| Maximum Voltages | 240 / 415 Vac, 80 Vdc | 80 Vdc | 60 Vdc | 125 Vdc |
| Current Ratings | 0.1 - 60 A(ac) 0.1 - 100 A(dc) | 110 - 250 A | 125 A, 250 A, 300 A | 0.1 - 60 A |
| Ics | 5 kA (DC), 1.25kA (AC) | 5 kA | 2.5kA | 2.5kA |
| Icu | 3 kA (AC) 5 kA (AC) 10 kA (DC) | 10 kA | 5 kA | 5 kA |

| Product Type | Circuit Breaker | Circuit Breaker | Circuit Breaker |
|------------------|---|-----------------------------|----------------------------|
| Approvals | UL489 | UL489 A, CSA C22.2 No. 5-16 | UL489A, CSA C22.2 No. 5-16 |
| Number of Poles | RAU + 1, RAU + 2, RAU + 3 | RAU + 1, RAU + 2, RAU + 3 | RAU + 2, RAU + 3 |
| Maximum Voltages | 120 Vac, 120 / 240 Vac, 240 Vac, 80 Vdc | 60 Vdc | 80 Vdc |
| Current Ratings | 0.1 - 80 A(ac) 0.1 - 100 A(dc) | 125 A, 250 A, 300 A | 110 - 250 A |
| AIC | AC - 10 kA, DC - 20 kA | 14 kA | 20 kA |

| Product Type | Circuit Breaker | Circuit Breaker |
|-----------------------|--|--|
| Approvals | IEC / EN 60934, CE, GB17701 | UL1077, cURus |
| Number of Poles | 1 - 4 | 1 - 6 |
| Maximum Voltages | 240 / 415 Vac, 80 Vdc | 277 / 480 Vac, 80 Vdc |
| Current Ratings | 0.1 A - 100 A (1 p), 0.1 A - 70 A (2 - 3 p) | .1 A - 100 A (1 p), 0.1 A - 70 A (2 - 4 p) |
| Interrupting Capacity | - | 2 kA/U2/ U3 (AC) 5 kA/C1 (AC) 5 kAU2/ U3 (DC) |
| Rated conditional S/C | 3 kA (AC) PC1, 5 kA (DC) PC1 | - |
| Icm | - | - |

Verify approvals for specific ratings in accordance with the relevant test certificate

Torque Table

| Description | Size | Torque Value |
|-------------------|----------|----------------|
| Front Inserts | M3 | 0.5 - 0.8 N.m |
| | 6 - 32 | 5 - 7 lbf.in |
| Rear Studs | M5 | 2.0 - 2.8 N.m |
| | 10 - 32 | 18 - 24 lbf.in |
| | M6 | 3.5 - 4.0 N.m |
| | 1/4 - 20 | 30 - 35 lbf.in |
| Flush Rear Screws | M5 | 1.7 - 2.3 N.m |
| | 10 - 32 | 15 - 20 lbf.in |

Continues on page 3

Remote Actuator Unit (RAU) for DD-Frame (D7)

| Aux Switch Specification | |
|--------------------------|---|
| Gold DB3 | EN61058 0.1 A @ 250 Vac & 0.1 A @ 80 Vdc and UL1054 0.1 A @ 125/250 Vac & 0.1 A @ 30 Vdc & 0.3 A @ 60 Vdc |
| Silver DB2 | EN61058 10 A @ 250 Vac & 0.1 A @ 80 Vdc and UL1054 10 A @ 125/250 Vac |
| Silver V4D | EN61058-1 10 A @ 250 Vac |

Ordering Information

| Group 1: Frame | Code | Description | Comments | | | | | |
|---|------|--|---|------------------------|------|--|-----------|------------------------|
| | D | DD-Frame RAU | | | | | | |
| Group 2: Type | Code | Description | Comments | | | | | |
| | 7 | RAU Non-Lockout type (18 - 80 Vdc) Fitted on Left of Circuit Breaker | RAU D7 + 1 st Circuit Breaker pole | | | | | |
| | 2 | Additional Circuit Breaker pole | Maximum of 2 additional Circuit Breaker poles | | | | | |
| Group 3: Mounting | Code | Description | Comments | | | | | |
| | A | Front Mount, Rectangular Aperture - Standard Toggle Handle | Maximum penetration depth into the product by the mounting screw is 6mm | | | | | |
| Group 4: Handle Type or Blank for Reduced Handle | Code | Description | Comments | | | | | |
| | A | Standard Toggle Handle | Standard Toggle Handle, goes to Off Position when tripped | | | | | |
| Group 5: Termination | Code | Description | Comments | | | | | |
| | 3X | Plug in (Bullet) Terminal (dia 7.8 mm x 16.4 mm) | 100 A Max per terminal (80 Vdc) & 125 A Max per terminal (60 Vdc). Ensure the connector has sufficient space so as not to interfere with the terminal bar | | | | | |
| | 4X | Flush Rear Screw Terminal, (M5 or 10 - 32) | 50 A max per terminal | | | | | |
| | 5X | Double Quick Connect Terminal (0.8 mm x 6.35 mm) | 50 A Max per terminal | | | | | |
| | AX | Stud Terminals, (M5 or 10 - 32) | 60 A Max per terminal | | | | | |
| | MX | Stud Terminals, (M6 or 1/4 - 20) | 125 A Max per terminal | | | | | |
| Group 6: Total No. of Poles | Code | Description | Comments | | | | | |
| | 2 | Two pole – METRIC - RAU + 1 DD Circuit Breaker pole | Two pole modules in total | | | | | |
| | 3 | Three pole – METRIC - RAU + 2 DD Circuit Breaker poles | Three pole modules in total | | | | | |
| | 4 | Four pole – METRIC - RAU + 3 DD Circuit Breaker poles | Four pole modules in total | | | | | |
| | B | Two pole – IMPERIAL - RAU + 1 DD Circuit Breaker pole | Two pole modules in total | | | | | |
| | C | Three pole – IMPERIAL - RAU + 2 DD Circuit Breaker poles | Three pole modules in total | | | | | |
| | D | Four pole – IMPERIAL - RAU + 3 DD Circuit Breaker poles | Four pole modules in total | | | | | |
| Group 7: Rated Voltages and Frequency - Main Circuit | Code | Description | Comments | | | | | |
| | H | 125Vdc | 0.1 A - 60 A Max. (Single pole only) | | | | | |
| | J | 120Vac, 240Vac (Applicable to Listed Single Pole DD Frame Circuit Breaker) | Refer to Certificates for Approval details | | | | | |
| | K | 240 Vac; 277Vac (Applicable to Recognized Single Pole DD Circuit breaker) | Refer to Certificates for Approval details | | | | | |
| | M | AC & DC Application for Multipole Units (80 Vdc, 240Vac, 240/415 Vac & 277/480 Vac) | Refer to Certificates for Approval details | | | | | |
| | N | 80 Vdc | Refer to Certificates for Approval details | | | | | |
| | R | 120/240 Vac, 240 Vac, 240/415 Vac; 277/480 Vac (Applicable to Recognized Multipole Products) | Refer to Certificates for Approval details | | | | | |
| | S | 120/240 Vac, 240 Vac or 240/415 Vac (Applicable to Listed Multipole Products) | Refer to Certificates for Approval details | | | | | |
| | V | 60 Vdc | No Trip Alarm, Mid Trip | | | | | |
| Group 8: Time Delay Characteristics (Pulse Tolerance @ 10 ms) | Code | Description | System | Pulse Tolerance (X In) | Code | Description | System | Pulse Tolerance (X In) |
| | AD | Long delay 50 / 60 Hz AS & dual rated | AC and DC | 8 - 10 | CH | Short delay 50 / 60 Hz CS & high inrush | AC | 12 - 15 |
| | BD | Medium delay 50 / 60 Hz BS & dual rated | AC and DC | 8 - 10 | AS | Long delay 50 / 60 Hz | AC or DC | 8 - 10 |
| | CD | Short delay 50 / 60 Hz CS & dual rated | AC and DC | 6 - 8 | BS | Medium delay 50 / 60 Hz | AC or DC | 8 - 10 |
| | AE | Long delay 50 / 60 Hz AH & inertia delay | AC | 28 - 35 | CS | Short delay 50 / 60 Hz | AC or DC | 6 - 8 |
| | BE | Medium delay 50 / 60 Hz BH & inertia delay | AC | 28 - 35 | AW | Long delay 50 / 60 Hz AD & inertia delay | AC and DC | 16 - 20 |
| | CE | Short delay 50 / 60 Hz CH & inertia delay | AC | 28 - 35 | BW | Medium delay 50 / 60 Hz BD & inertia delay | AC and DC | 16 - 20 |
| | AI | Long delay 50 / 60 Hz AS & inertia delay | AC or DC | 16 - 20 | CW | Short delay 50 / 60 Hz CD & inertia delay | AC and DC | 12 - 15 |
| | BI | Medium delay 50 / 60 Hz BS & inertia delay | AC or DC | 16 - 20 | H3 | Short delay | DC | 6 - 8 |
| | CI | Short delay 50 / 60 Hz CS & inertia delay | AC or DC | 12 - 15 | OP | Instantaneous trip 50 / 60 Hz | AC or DC | None |
| | AH | Long delay 50 / 60 Hz AS & high inrush | AC | 16 - 20 | OX | Switch 50 / 60 Hz | AC and DC | |
| | BH | Medium delay 50 / 60 Hz BS & high inrush | AC | 16 - 20 | | | | |

Continues on page 4

Remote Actuator Unit (RAU) for DD-Frame (D7)

Ordering Information

| Code | Description | Comments | |
|---|--|--|--|
| Group 9: Main Circuit Current | XXXX | No current, for voltage trip poles | |
| | 100M | 0.1 A | |
| | 0100 | 1 A | |
| | 1000 | 10 A | |
| | K250 | 250 A | |
| | | Specific Ampere rating possible from 0.1 A to 250 A (80 Vdc) 300 A (60 Vdc) | |
| Group 10: Circuit Configuration (circuit breaker's internal construction) | Code | Description | Comments |
| | BX | Circuit Breaker (Series Trip Current Sensing) | |
| | KX | Circuit Breaker with Auxiliary Switch | |
| MX | Circuit Breaker with Trip Alarm, but NO Mid Trip (Reversed Function - Latch Type) | Handle goes to OFF position when tripped and send a Trip Alarm | |
| Group 11: Auxiliary and Alarm Switches Types & Options (Refer to Aux switch specification on page 2) | Code | Description | Comments |
| | A | DB3-Gold Tips, Equally Spaced Terminals, 2.75 mm (0.108") - EN61058 0.1 A @ 250 Vac & 0.1 A @ 80 Vdc and UL1054 0.1 A | |
| | B | DB2-Silver Tips, Equally Spaced Terminals, 2.75mm (0.108") - EN61058 10 A @ 250 Vac & 0.1A @ 80 Vdc and UL1054 10A | |
| | C | V4D - Silver Tips, Offset Terminals, 4.75 mm (0.189") - (10 A @ 250 Vac) | |
| | M | Parallel Bridge Housing - For all Parallel Bridged Poles | Use M for ALL Parallel Bridged Products |
| | X | Not Applicable | |
| Group 12: Voltage and Current Ratings for Dual Control, Shunt and Relay Trip Construction | Code | Description | Comments |
| | XX | Not applicable | |
| Group 13: Terminal Options for Dual Control, Shunt and Relay Coils | Code | Description | Comments |
| | X | Not applicable | |
| Group 14: Future Use | Code | Description | Comments |
| | X | Not applicable | |
| Group 15: Customer Specific | Code | Description | Comments |
| | X | Not applicable | |
| | S | Customer Specific Product | |
| Group 16: Handle Colour | Code | Description | Comments |
| | B | Black handle, white marking. | Standard Toggle handle only |
| | W | White handle, black marking | Standard Toggle handle only |
| Group 17: Handle Markings | Code | Description | Comments |
| | D | I - O/On - Off | |
| Group 18: Mounting Orientation for Marking | Code | Description | Comments |
| | V | Vertical, Standard Mounting, Line at the Top | |
| Group 19: Front Plate Marking and Test Button | Code | Description | Comments |
| | A | Standard Marking on Standard Toggle handle | I - O and ON - OFF and ampere rating |
| Group 20: Inter-phase Barrier and Terminal Cover | Code | Description | Comments |
| | 1 | Terminal cover(s) | |
| | 2 | Inter-phase barrier & terminal cover - small | |
| | 3 | Inter-phase barrier & terminal cover - large | |
| | 4 | Inter-phase barrier & terminal cover - Z type | |
| | A | Inter-phase barrier - small | Inter-phase barriers and terminal covers may be required for multi-pole products with UL listed and UL recognised approvals. See DD-Frame Technical Guide. |
| | B | Inter-phase barrier - large | |
| | C | Inter-phase barrier - Z type large | |
| | D | Inter-phase barrier - Z type small | |
| X | Not applicable | | |
| Group 21: Approvals (Product Normally Approved to) | Code | Description | Comments |
| | 1 | UL recognized UL1077, CUR, IEC/EN60934, CE, UKCA | Normally certified to these specifications |
| | 2 | UL listed UL489, CUL, IEC/EN60947-2, CE, UKCA | Normally certified to these specifications |
| | 3 | UL listed UL489A, IEC/EN60947-2, CE, UKCA | Normally certified to these specifications |
| Group 22: Safety Marks | Code | Description | Comments |
| | X | Not applicable | |
| | C | GB/T 14048.2, CCC | |

Verify approvals for specific ratings in accordance with the relevant test certificate

Remote Actuator Unit (RAU) for DD-Frame (D7)

Connection Diagrams

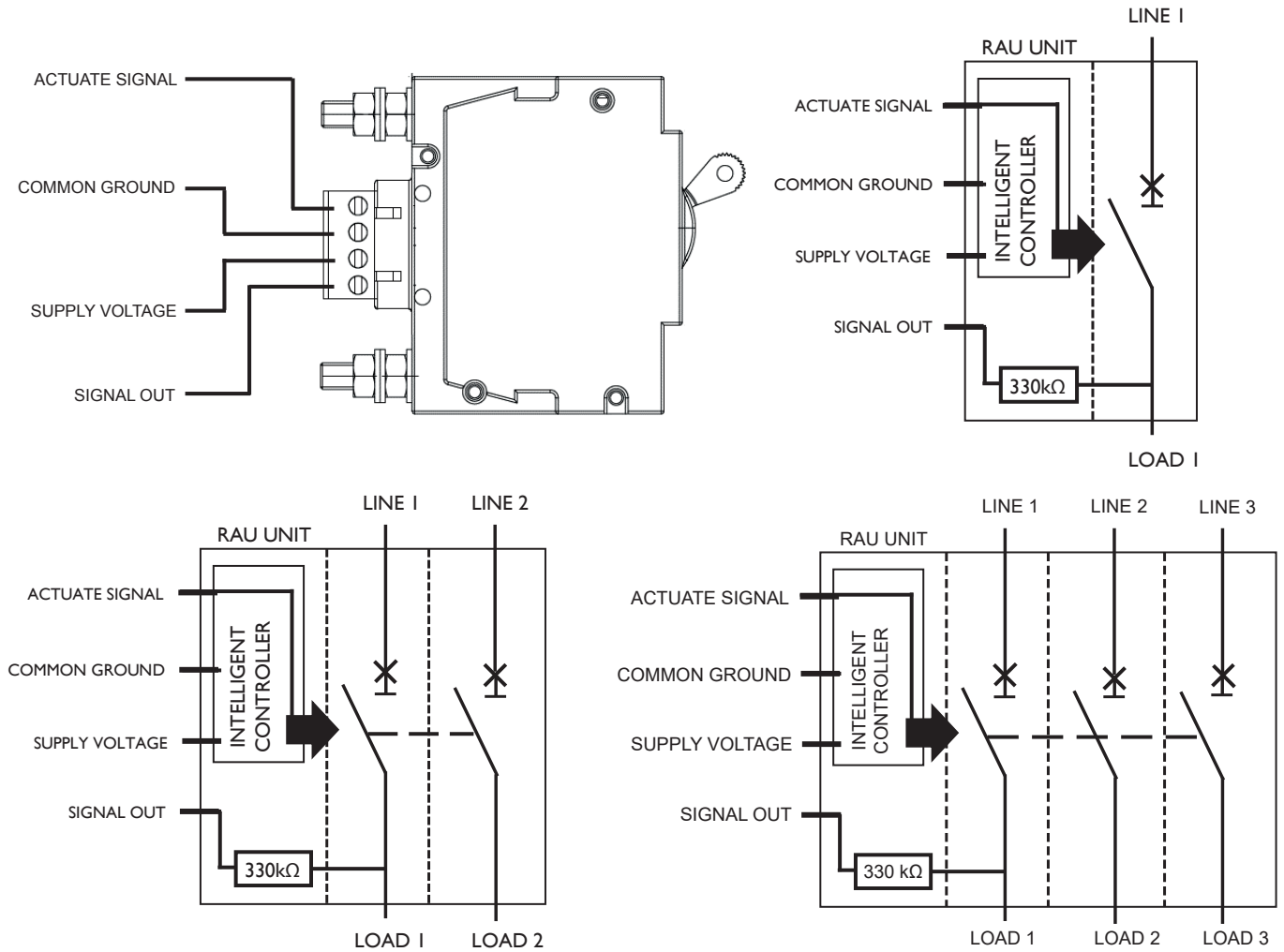

Note: Signal out only provides status indication of the adjacent pole through a 330 kΩ resistor.

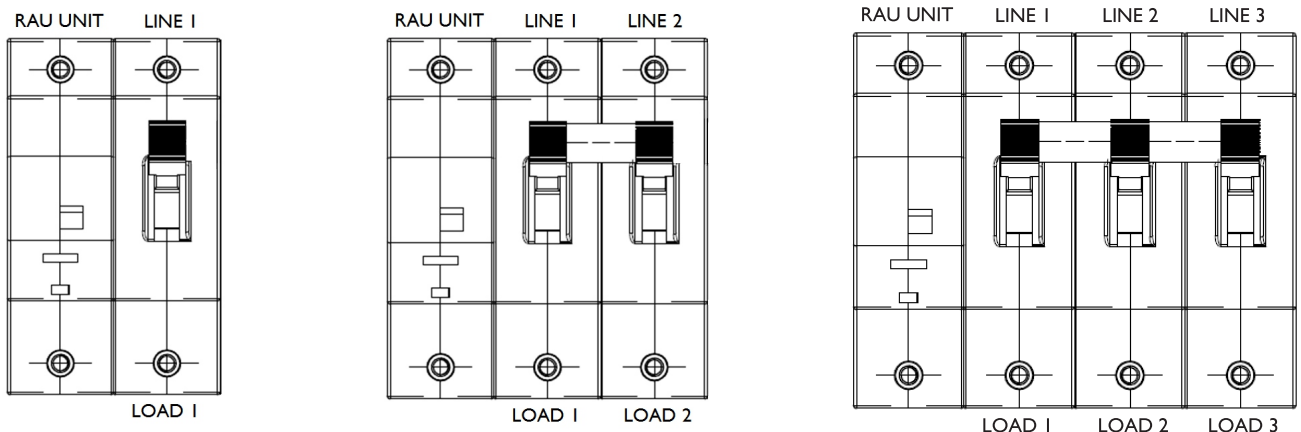

Remote Actuator Unit (RAU) for DD-Frame (D7)

Plug compatible with DEGSON 2EDGKF-5.08-04P -14 and a PHOENIX CONTACT plug 1780002.

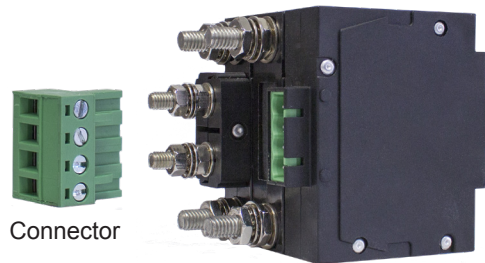

The RAU front switch has two positions, namely "Pulse" or "Constant". Refer to RAU Operation on page 7 for more details.

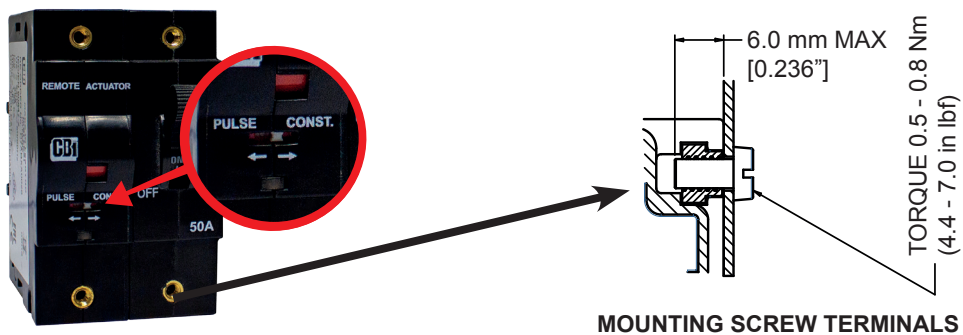

Installation Instructions

1. Before connecting the RAU to power, the circuit breaker must be in the OFF position and the RAU front switch must be set to the user's option of PULSE or CONSTANT.
2. Isolate the power to the circuit breakers.
3. Connect the circuit breakers as required and connect the necessary wiring for the RAU as shown in the connection diagram (page 5).
4. With the circuit breaker in the OFF position, activate the supply to the circuit breakers and the RAU. The LED on the RAU will flash 3 times during its initialisation process.

Remote Actuator Unit (RAU) for DD-Frame (D7)

The RAU Operation

1. RAU initial conditions

- RAU in OFF position
- Actuation signal OFF
- Supply voltage ON
- LED flashes 3 times
- RAU manual operation possible

2. Operations in PULSE mode (The LED is ON)

- Apply a pulse signal, the RAU will actuate ON
- Apply another the pulse signal, the RAU will actuate to the OFF position

3. Operations in CONSTANT mode (The LED is always OFF)

- Apply a constant signal, the RAU will actuate ON
- Remove the constant signal and the RAU will switch OFF

4. Changing Mode

Use a small tool to slide the front switch between CONSTANT and PULSE modes. The LED state will confirm the selection

Note: when moving the front switch from PULSE mode to CONSTANT mode while powered, may cause the breaker to inadvertently switch off, due to the signal level being low

5. Relatching

To relatch after an overcurrent trip, send a signal to turn off and back on again

NOTE:

- **DO NOT** move or block the circuit breaker handles while the RAU is actuating remotely.
- **DO NOT** change the state of the actuate signal or RAU front switch rapidly, or while the circuit breaker is in motion, allow at least a 3 seconds waiting period before changing the state.

Remote Actuator Unit (RAU) for DD-Frame (D7)

LED Status Indication Confirmation

| LED State | Indication |
|-------------------------------|--------------------------------|
| Flash 3 times | Initialisation |
| Flash 3 times every 4 seconds | Fault state |
| ON | Pulse actuation signal mode |
| OFF | Constant actuation signal mode |
| 2 Short flash & 1 long flash | Initialisation fault |

Application Notes:

RAU powered from Negative DC Bus

The DD-frame RAU requires a positive supply voltage between 18 Vdc and 80 Vdc to operate, however, systems may only have a negative voltage supply available. The RAU is able to accommodate such environments. Figure 1 shows an example of an RAU in a telecommunications application which only has a -48 Vdc bus voltage available. Resistor R is required if the potential difference between the Actuate Signal pin and the Common pin is greater than 60 Vdc.

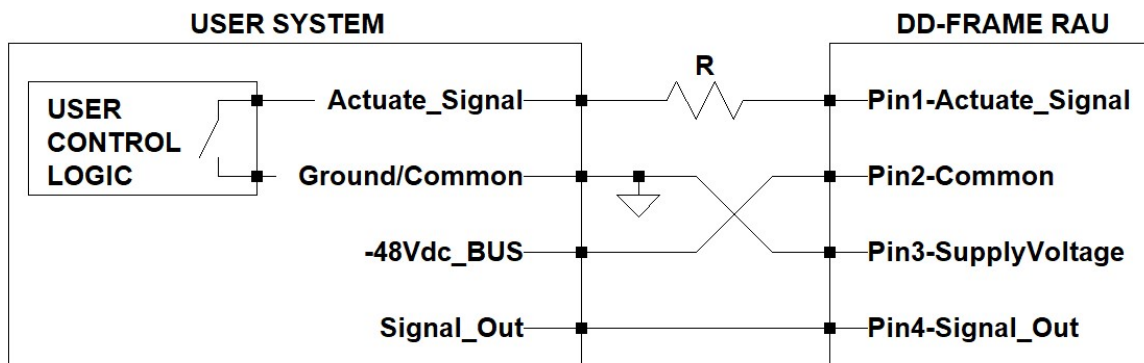

Figure 1: Wiring diagram example for DD-Frame RAU powered from negative supply bus in a -48 Vdc telecommunications application

Remote Actuator Unit (RAU) for DD-Frame (D7)

Using the Signal Out

Signal out can have many functions and is not just an auxiliary contact to indicate the open / closed state of the circuit breaker. The signal out function will depend on its specific application. This application note will convey the function of signal out for various applications under resistive loads only.

The signal out contact is connected only to the adjacent pole LOAD side and is isolated from the control.

Note that the signal out will vary depending on the type of load and will need to be taken into consideration when designing the RAU into a system.

Table 2: Wiring Configuration

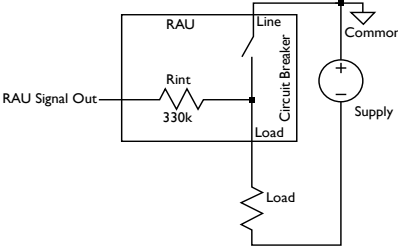
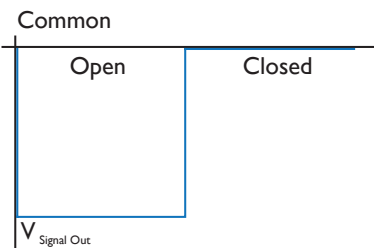
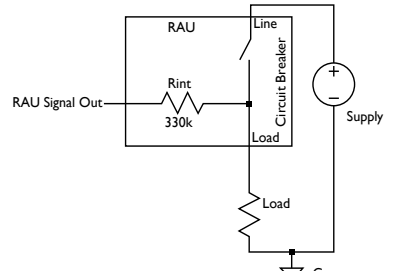
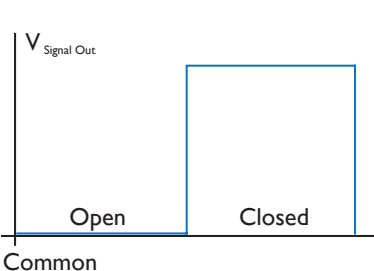
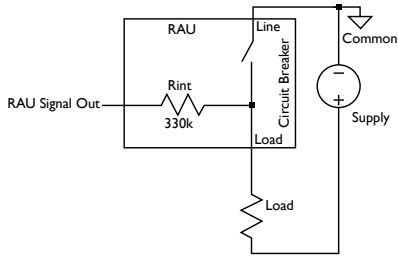
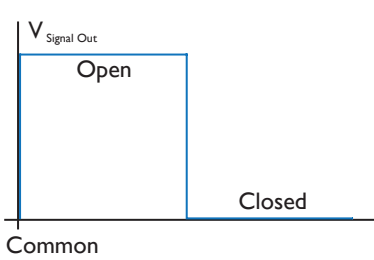
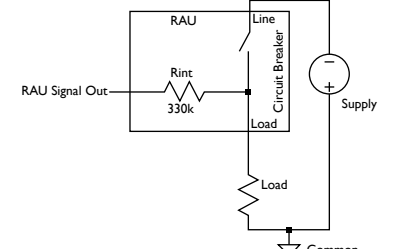
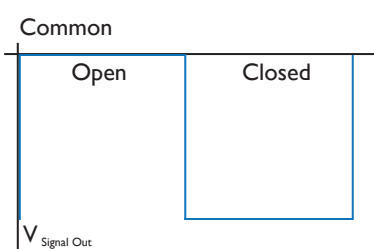
| Wiring Configuration | Signal Out with reference to common when circuit breaker is open or closed | Purpose of Signal out |
|---|--|-----------------------------------|
|  |  | Monitor status of circuit breaker |
|  |  | Monitor status of circuit breaker |
|  |  | Monitor status of circuit breaker |
|  |  | Monitor status of circuit breaker |

Remote Actuator Unit (RAU) for DD-Frame (D7)

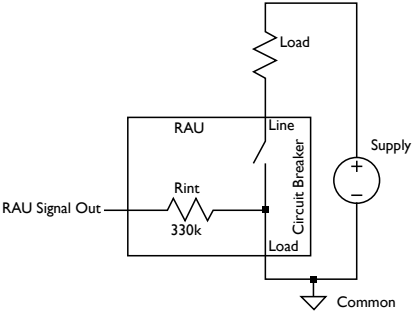
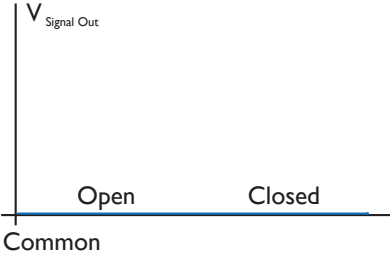
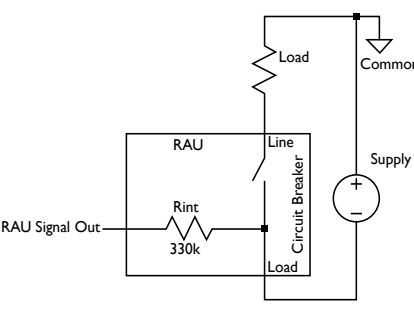
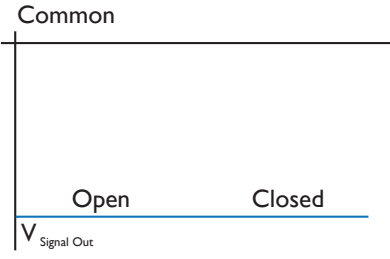
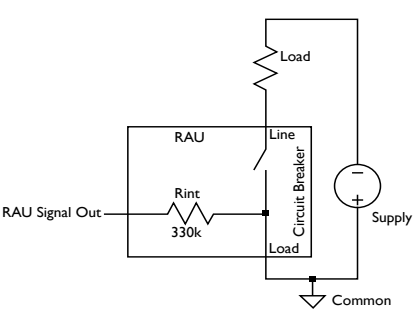
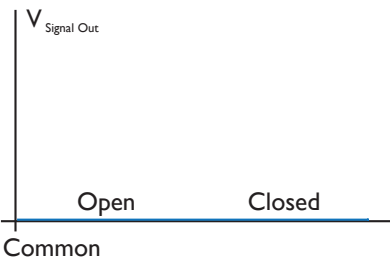
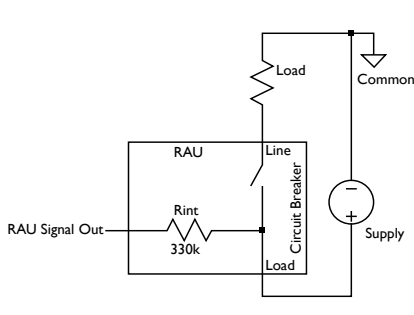
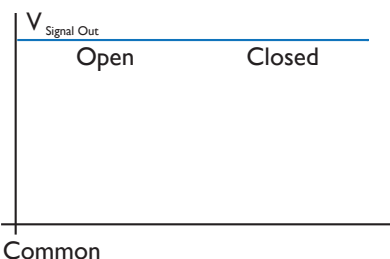
| Wiring Configuration | Signal Out with reference to RAU Common | Purpose of Signal out |
|---|--|-----------------------------|
|  |  | Common potential monitoring |
|  |  | Monitor Supply |
|  |  | Common potential monitoring |
|  |  | Monitor supply |

Remote Actuator Unit (RAU) for DD-Frame (D7)

Actuation Signal Voltage Greater than 60 Vdc

The maximum actuation signal voltage that can be applied to the DD-Frame RAU is 60 Vdc. If the application is such that the actuation signal voltage will be larger than 60 Vdc, then an external resistor must be added in series as indicated in figure 2.

The value of the resistor can be designed for using the following equation:

$$R = \left(\frac{V_{\text{supply}} - 60}{0.001} \right) \text{ with deviation of } \pm 20\%$$

For example, if the actuation signal voltage will be 72 Vdc, then a 12 kΩ resistor must be added in series. See table 3.

External resistor to add in series for actuation signal voltage above

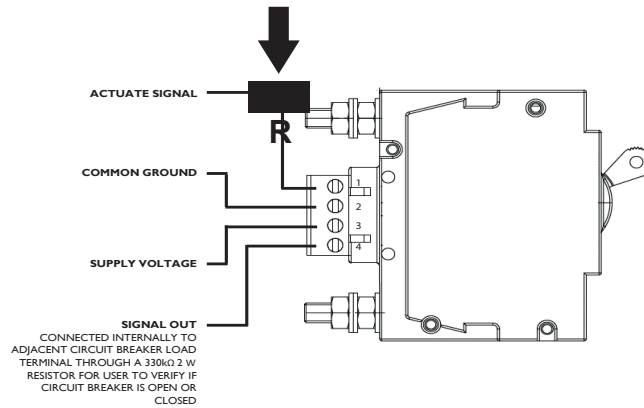

Figure 2: Side view of DD-Frame RAU indicating how to add resistor in series for actuation signal voltages above 60 Vdc

Table 3: Actuation signal voltages and corresponding resistor values to be added in series

| Actuation Voltages in Volts dc | External resistor to add in series with actuate terminal (E12 series) |
|--------------------------------|---|
| 72 | 12 kΩ |
| 80 | 22 kΩ |

Alternatively, a voltage divider may be implemented to create a signal voltage between 5 Vdc and 60 Vdc. The minimum current required by the actuation signal input is 5 mA.

Dimensional Drawings

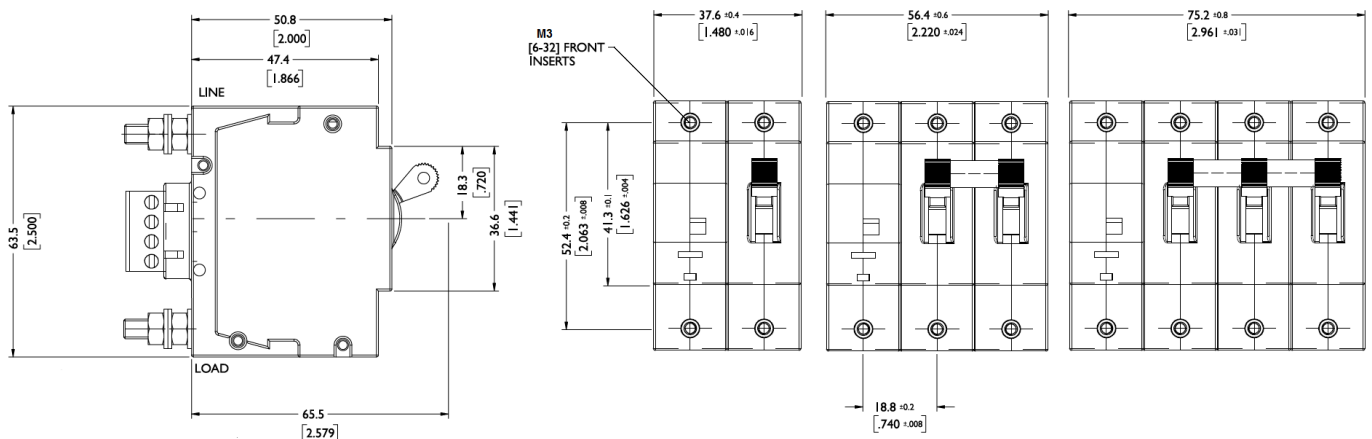

Remote Actuator Unit (RAU) for DD-Frame (D7)

Outline Dimensions: Panel Cutout Standard Handle

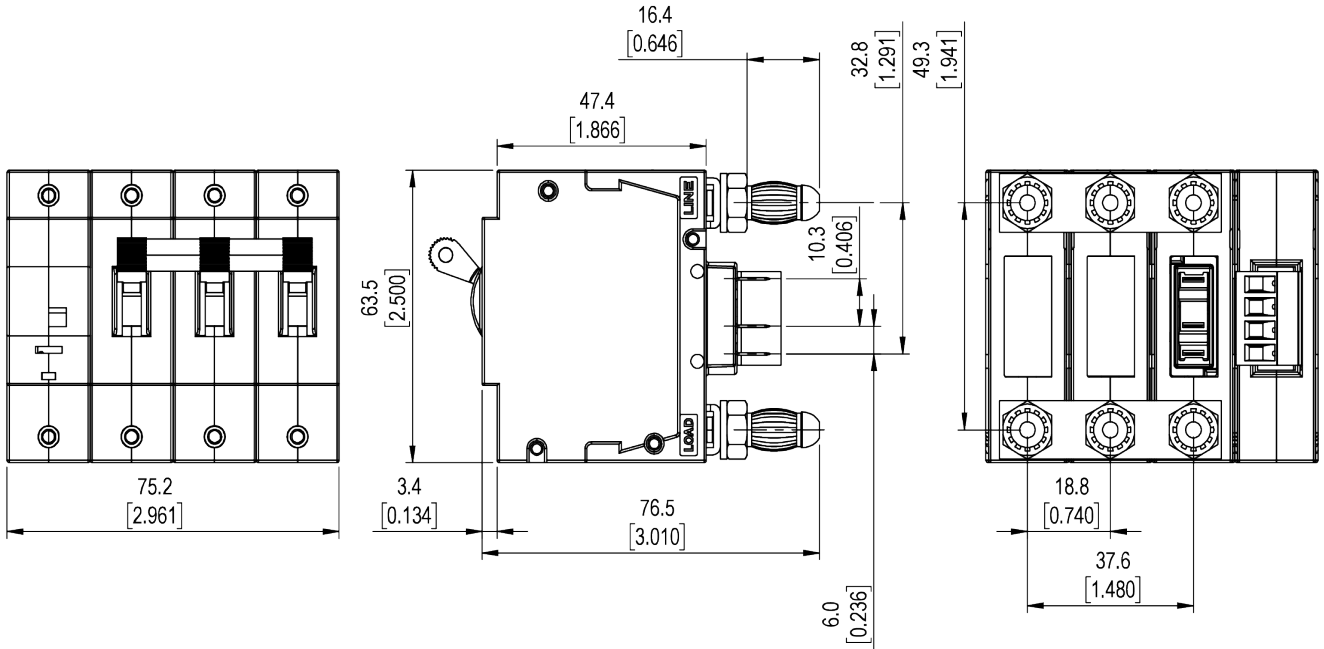

NOTES:

1. TOLERANCE $\pm 0.4\text{MM}$ UNLESS STATED.
2. ALL DIMENSIONS IN BRACKETS ARE IN INCH.

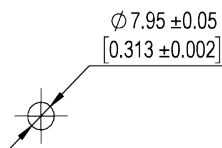
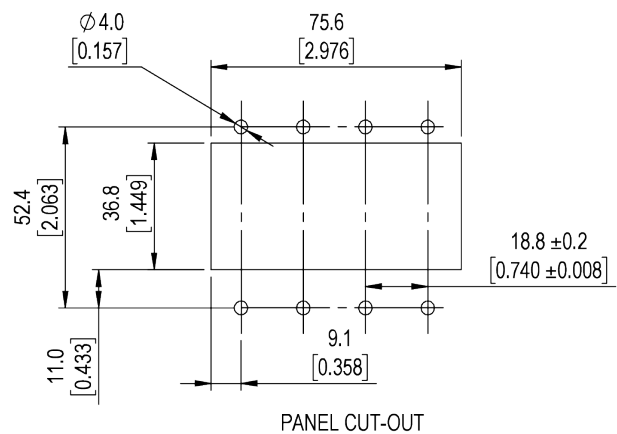

PLUG-IN MATING HOLE

| PLUG IN TYPE SIZE | A | B | C | D |
|----------------------------|-------------|-------------|-------------|-------------|
| PLUG IN LARGE (7.80mm DIA) | 24.3 [.957] | 16.4 [.646] | 7.80 [.307] | 7.95 [.313] |

* Other plug-in version available on special request up to 80 A

Please review our Customer Terms and Conditions on www.cbi-lowvoltage.co.za

© CBI (Pty) Ltd. All Rights Reserved.

All rights reserved. Unless otherwise indicated, all materials on these pages are copyrighted by CBI (Pty) Ltd. No part of these pages, either text or image may be used for any purpose other than personal use. Therefore, reproduction, modification, storage in a retrieval system or retransmission, in any form or by any means, electronic, mechanical or otherwise, for reasons other than personal use, is strictly prohibited without prior written permission. CBI (Pty) Ltd reserves the right to alter any details of this document without notice and while every effort is made to ensure the accuracy of the content, no warranty is given as to the accuracy of this document and no responsibility will be accepted for error or misinterpretation and any resulting loss.

AUSTRALIA

CBI-electric: Australia
27 Wedgewood Rd, Hallam
Victoria 3803 Australia
Tel: +61 3 8752 9300
Fax: +61 3 9796 5407
Email: sales@cbi-electric.com.au
Website: www.cbi-electric.com.au

INDIA

CBI-electric: Asia
A1, Pushpagiri Residency, 1st Cross
2nd Main, Jyothi Nagar, B.G Road
Bengaluru 560083, India
Tel: +91-9880553153
Email: salesasia@cbi-electric.com
Website: www.cbibreakers.com
Website: www.cbi-lowvoltage.com

SOUTH AFRICA

CBI-electric: low voltage
Tripswitch Drive Elandsfontein
Gauteng South Africa
Tel: +27 11 928 2000
Fax: +27 11 392 2354
Email: cbi@cbi-electric.com
internationalsales@cbi-electric.com
Website: www.cbi-lowvoltage.com

USA

CBI-electric: North America
35 E. Uwchlan Ave Suite 328
Exton PA 19341 USA
Tel: +1 610 524 9949
Fax: +1 610 524 9945
E-mail: info@cbibreakers.com
Website: www.cbibreakers.com